

Dimensions:

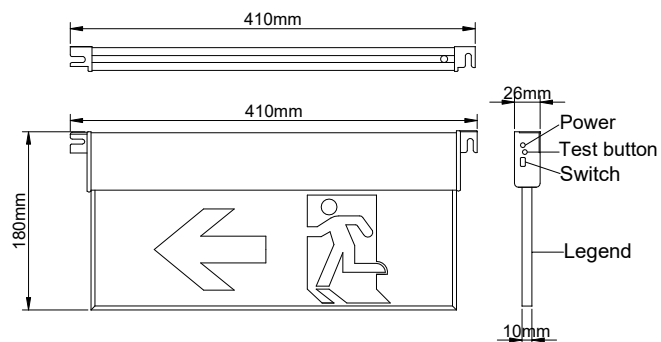

Technical Specification:

Item	Part Number	C412LEDSC
	Description	High-brightness LED provides the function of normal illumination and emergency lighting
Input	Voltage	110VAC ~ 240VAC
	Frequency	50/60Hz
Output	Light Source	High efficacy LED 5W
	Power Consumption	Fully charged (Standby) 2.5W
	Battery	Ni Mh 12V 800mAh
	Emergency Duration	Over two hours
Physical	Appearance Material	Appearance of Ballast uses flame-retardant, ABS polyester base
	Mounting	Surface mounted - wall or ceiling
	Dimensions L x W x H	410mm x 180mm x 25mm
	Weight	0.7 KG
	IP rating	IP 20
Controls	Charger	Trickle charging
	Protection	Overcharge, overcurrent
	Testing Facility	Manual test switch
	Indicator	Battery charger RED LED
Environment	Operating Temperature	5°C to 40°C
	Relative Humidity	0 to 95%

